



HAL
open science

Electrical vehicle feeding by association of ultracapacitors and photovoltaic generators

A Djerdir, K El Kadri Benkara, A. Miraoui

► **To cite this version:**

A Djerdir, K El Kadri Benkara, A. Miraoui. Electrical vehicle feeding by association of ultracapacitors and photovoltaic generators. *Electromotion*, 2003. hal-01997180

HAL Id: hal-01997180

<https://utc.hal.science/hal-01997180v1>

Submitted on 28 Jan 2019

HAL is a multi-disciplinary open access archive for the deposit and dissemination of scientific research documents, whether they are published or not. The documents may come from teaching and research institutions in France or abroad, or from public or private research centers.

L'archive ouverte pluridisciplinaire **HAL**, est destinée au dépôt et à la diffusion de documents scientifiques de niveau recherche, publiés ou non, émanant des établissements d'enseignement et de recherche français ou étrangers, des laboratoires publics ou privés.

Electrical vehicle feeding by association of ultracapacitors and photovoltaic generators

A. Djerdir, K. Elkadri, A. Miraoui
UTBM – L2ES Bât – F, Rue Thierry Mieg, 90010 Belfort Cedex - France
Abdesslem.djerdir@utbm.fr

Abstract-- the aim of this work is to study the association of the ultracapacitors and photovoltaic generators to feed an electrical vehicle. In order to size these components, two electrical models have been proposed starting from their physical behaviours. Two DC-DC converters for the energy management between the photovoltaic generator, the ultracapacitors and the dc bus of the electrical vehicle, have been proposed. The simulation of their functionalities gives good results and shows the possibility to achieve this new application.

Index terms-- electrical vehicle, ultracapacitors, DC-DC power converters, photovoltaic generator.

1. INTRODUCTION

The power fluctuations are prejudicial to the battery. So, its useful life decreases considerably in such operation (significant and repetitive of power peaks). The ultracapacitors, by their strong power density and their great ability to be charged and discharged, are more able than the batteries to provide these necessary peaks of power at the convenient periods [1]. In the reference [2], the authors describe an electrical train for which the electrical feeding is completely ensured by ultracapacitors. The later are charged from the electrical network during the train stations. This process allows solving the problem of the limited autonomy of ultracapacitors regarding to the batteries one. Furthermore, the railway electric lines are suppressed as well as the related costs.

In this paper we present a study of an association of a photovoltaic generator to ultracapacitors in order to ensure the electric train feeding. Two packs of ultracapacitors are used : the first one is located at the train station where it is charged with a low current (slow charging). The second pack is aboard of the train and it is charged from the first pack under a high current (fast charging), see figure 1. This study shows the used methodologies to choose the converters conv1 and conv2, their sizing and their control strategies. The ultracapacitor packs and photovoltaic generators sizing are also treated. Finally, some simulation results of different functionalities of this new system are included.

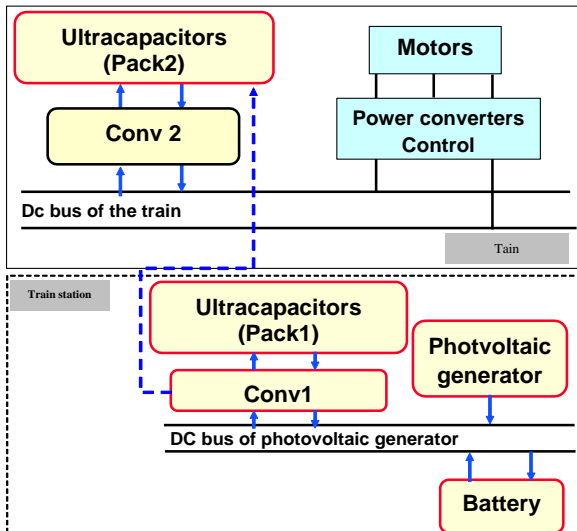

Figure 1 : Energetic scheme of the studied system

2. INSERTION OF ULTRACAPACITORS IN AN ELECTRIC VEHICLE

The voltage level of the DC bus of the electric vehicles is generally about 400V. So, to be able to use the ultracapacitors as principal source of energy in these vehicles, we must consider a conditioning of their voltage with that of the vehicle. The voltage and current levels acceptable by the currently available ultracapacitors are respectively 2.3V and 400A. Thus, their use in a higher voltage and current environments requires their assembly in series or series/parallel. In order to insert the ultracapacitors pack thus gathered, within an electric vehicle, two solutions may be considered : a pack directly connected on the DC bus or through a lifting stage of voltage. At the end of a comparative study between possible conditioner structures, we retained a DC/DC converter based on the boost/back topology. The ratio between the voltage levels of the ultracapacitors pack and the DC bus is a very constraining parameter in the choice of the converter structures. Indeed, the current to cross by the conditioner converter is significant as well as the value of this ratio is high.

3. PHOTOVOLTAIC GENRATOR MODELLING

In order to size the photovoltaic generator and to study its real time operation, it is necessary to model it in dynamic operating mode. So, the current-voltage characteristics of this generator which are strongly non linear (figure 2) are used to achieve the dynamic modelling.

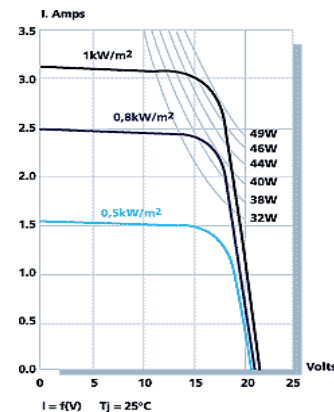

Figure 2 : Example of photovoltaic characteristics [7]

Several studies in different domains of engineering lead to the electrical model of photovoltaic generator which is presented in figure 3 [6]. We strike the fact that this generator has a voltage and current behaviours similar to that of a DC current source with a limited voltage. We note also that the photovoltaic generator is about 15% for silicon cells. Thus for a needed power P the solar panel (figure 3)

must have a surface $S = \frac{P}{0,15 \times 1000}$. Afterwards, one must

verifying if the current value of 3.2 A is effectively sufficient for the application. In the case of this value is very small one must grouping several panels in parallel.

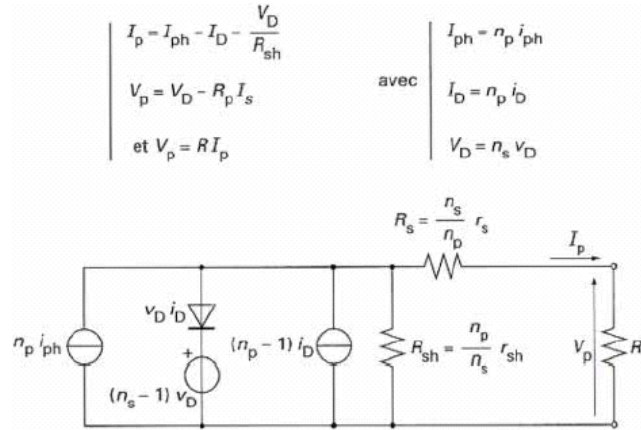

Figure 3 : Equivalent electrical scheme of a photovoltaic generator [6]

4. CHOICE OF THE CONVERTERS CONV1 AND CONV2

In order to adapt the ultracapacitors voltage to the DC bus one, it's necessary to use a conditioning converter (conv2). This converter must fulfil the following conditions :

1. The ultracapacitors voltage lifting to that of the DC bus.
2. The regulation of the voltage ratio between the chopper input and output.
3. Ensuring the current reversibility.

So, the searched converter is a DC-DC one with an inductive stage of energy storage. Thus, we chose the boost/back converter shown in figure 4. This structure is simple both for its command and its establishment. With the same way we lead to choose the same structure for conv2.

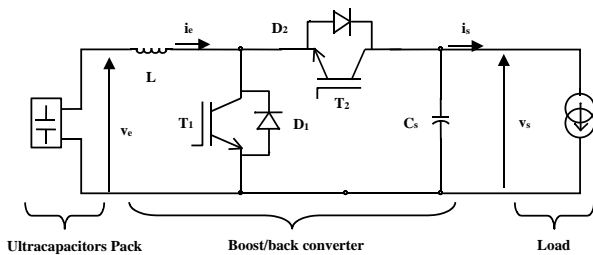

Figure 4 : boost/back converter

5. MINATURE TEST MODEL

This study concerns a miniature test model "1/24th scale" for that the main components are presented on figure 5. In this time, the train is Ac-Dc powered. Our target is to replace this feeding system by a solar-power one. To achieve this goal we must build the two converters conv1 and conv2 (figure 1). At this stage of the study, the ultracapacitors packs (pack1 and pack2) and the converters (conv1 and conv2) are sized and the different functionalities of the system have been simulated.

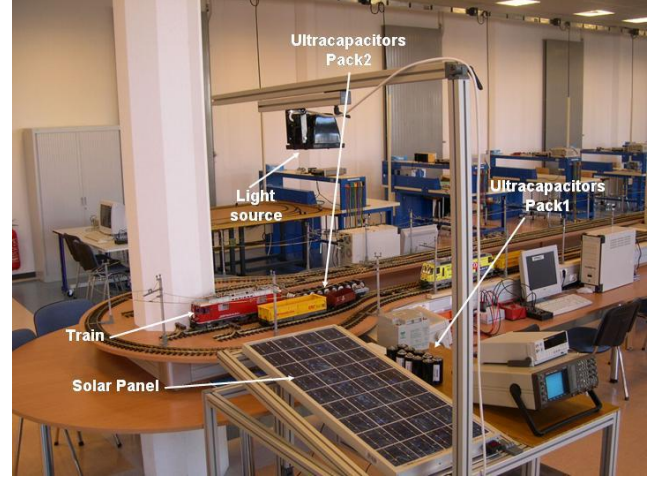

Figure 5 : Photos of the miniature test bunch

6. SIMULATION

The simulations have been achieved by using the Matlab/Simulink software. In this section we present the main simulation results showing the feasibility of this new application.

A. Low charge : photovoltaic generator – pack1 :

In order to see the magnitudes variations, we consider a small value of capacitance of the pack1 (6.76 F for example). We obtain the current and voltage variation in the low charge case, see figure 6.

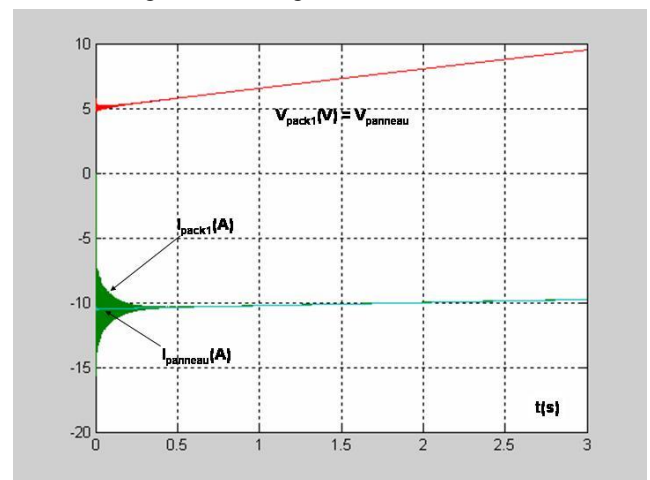

Figure 6 : voltages and currents of pack1 and photovoltaic generator during the low charging

B. Fast charging : pack1 – pack2 :

The pack1 is initially charged at 10 V, the pack2 at 12 V. The pack1 is discharged in pack2 through the converter conv1. The figures 7 and 8 show respectively the

currents and the voltages of both the packs of ultracapacitors.

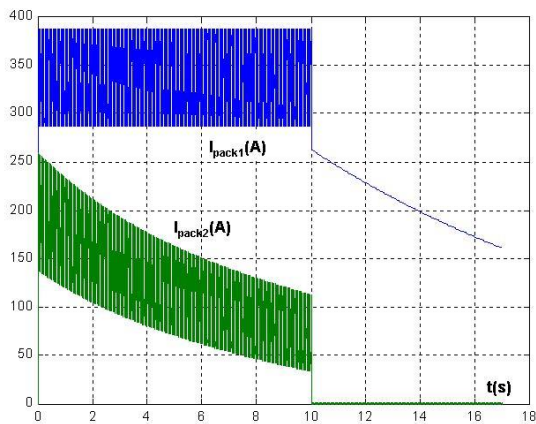

Figure 7 : current variations of pack1 and pack2

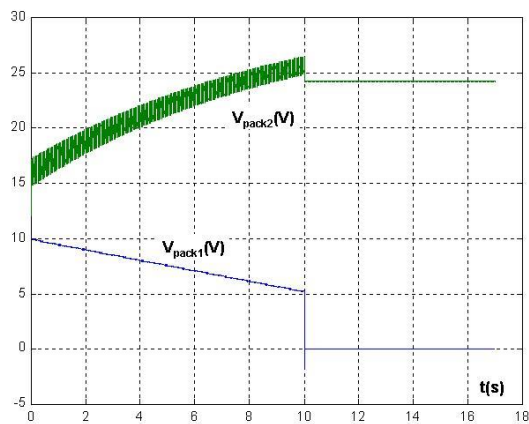

Figure 8 : voltage variations of pack1 and pack2

C. Pack2-Dc bus

This simulation highlight that the proposed system ensures well the voltage conditioning between the pack2 and the DC bus voltages of the electrical vehicle. The simulation results are presented on figures 9 and 10. It is clearly seen that the Dc bus of 24 V is fulfilled during the load cycle. We notice that the current in the pack2 increase when the corresponding voltage decreases.

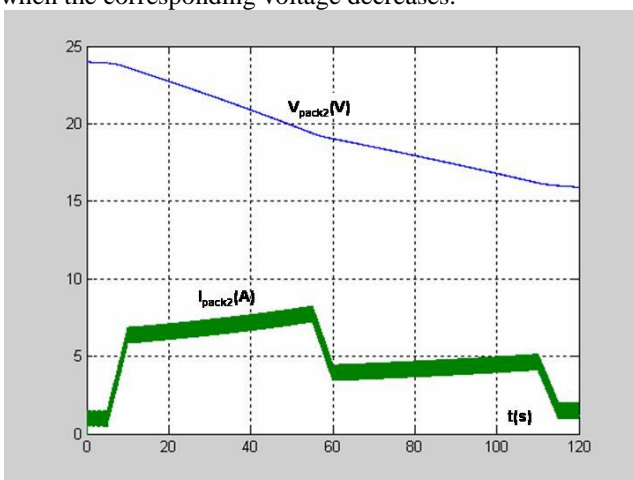

Figure 9 : Voltage and current of the pack2 during a load cycle

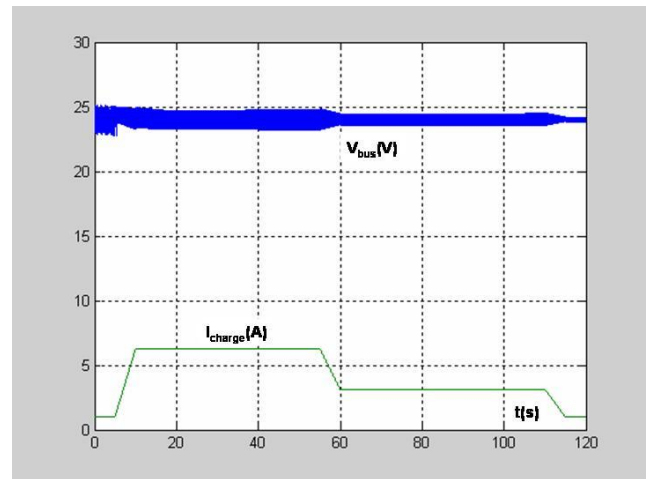

Figure 10 : Voltage and current of the Dc bus during a load cycle

7. CONCLUSION

This work assures us an obvious contribution of the ultracapacitors insertion into the motorization chain of electric vehicles. The combination of ultracapacitors and solar panels may be used to completely feed an electrical vehicle. The obtained simulation results are encouraging to start novel prospects in the renewable energy applications.

At this stage of the study, we are finalizing the test model building. So, several studies in the area of the electrical energy management may be experimented.

In the full paper, we will develop the study of the structure presented above. We will analyze the converters and their command. We will present some simulations and experiment results highlighting the operation of a "photovoltaic generator –conv1– pack1-conv1-pack2-conv2-dc bus and load" system. More details about the experiment aspects of this study will be also given.

8. RÉFÉRENCES

- [1] J-J. BEZIAN, "Systèmes de piles à combustibles pour la cogénération - état de l'art, Rapport réalisé pour l'ADEME", Oct. 1998.
- [2] A.Djerdir, D.Bouquain, H.Gualous, A.Berthon, Y.Ayad, I.Rasoanarivo, S.Rael, B.Davat. "Utilisation des supercondensateurs dans la chaîne de motorisation des véhicules à pile à combustible", Colloque sur les Piles à Combustibles et Interfaces pour les transports, Belfort, 8-9 nov 2000, pp 117-124.
- [3] P. Barrade, D. Hotellier, A. Ruffer, "Apport des supercondensateurs dans le transport terrestre : une meilleure gestion de l'énergie", Colloque sur le transport terrestre électrique, Belfort, 25 avril 2002, pp 40-46.
- [4] L. ZUBIETA, R. BONERT, "Characterization of Double-Layer Capacitors (DLCs) for power Electronics", IEEE 1998, pp 1149-1154.
- [5] A.Djerdir, D.Bouquain, H.Gualous, A.Berthon, "Managing ultracapacitors energy to feed electric vehicles DC bus", EPE conference graz, 2001, CD-ROM.
- [6] L. PROTIN, S. ASTIER, "Convertisseurs photovoltaïques, Techniques de l'Ingénieur" - Energie, D3360.
- [7] <http://www.photowatt.com>
- [8] <http://www.powercash.com>